

NOTE: This disposition is nonprecedential.

**United States Court of Appeals  
for the Federal Circuit**

---

**GOLDEN EYE MEDIA USA, INC.,**  
*Plaintiff-Counterdefendant-Appellee*

**FARZAN DEHMOUBED, JENNIFER DUVALL,**  
*Counterdefendants-Appellees*

v.

**EVO LIFESTYLE PRODUCTS LIMITED, FKA  
TROLLEY BAGS UK LTD,**  
*Defendant-Counterclaimant-Appellant*

---

2021-2096

---

Appeal from the United States District Court for the Southern District of California in No. 3:18-cv-02109-BEN-LL, Senior Judge Roger T. Benitez.

---

Decided: June 22, 2022

---

CODY R. LEJEUNE, LeJeune Law, PC, San Diego, CA, for appellees.

MATTHEW L. CUTLER, Harness, Dickey & Pierce, PLC, St. Louis, MO, for appellant. Also represented by Glenn E. Forbis, Troy MI.

---

Before LOURIE, SCHALL, and REYNA, *Circuit Judges*.

LOURIE, *Circuit Judge*.

Evo Lifestyle Products Limited, formerly known as Trolley Bags UK Ltd (“TB UK”), appeals from a decision of the United States District Court for the Southern District of California granting summary judgment in favor of Golden Eye Media USA, Inc. (“GEM”). The court held that TB UK’s U.S. Patent D779,828 (the “828 patent”) is invalid for reasons of functionality and obviousness, and that, even if it were valid, GEM did not infringe the patent or TB UK’s trademark. *See Golden Eye Media USA, Inc. v. Trolley Bags UK Ltd.*, 525 F. Supp. 3d 1145 (S.D. Cal. 2021) (“*Decision*”). *We affirm.*

#### BACKGROUND

TB UK owns the ’828 patent. This patent is directed to a reusable and foldable shopping bag that fits within a shopping cart. Figures 1–6 illustrate the claimed design.

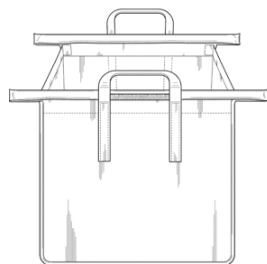

FIG. 1

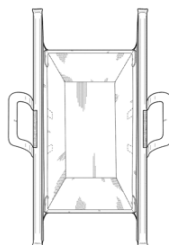

FIG. 2

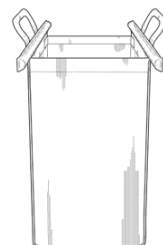

FIG. 3

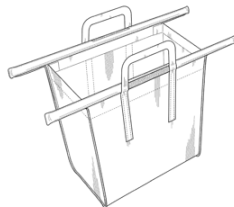

FIG. 4

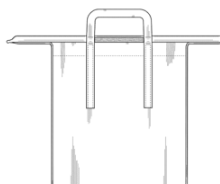

FIG. 5



FIG. 6

GOLDEN EYE MEDIA USA, INC. v.  
EVO LIFESTYLE PRODUCTS LIMITED

3

'828 patent at Figs. 1–6. TB UK also claims a common law trademark for “TROLLEY BAGS.” TB UK sells reusable shopping cart bags that use the mark “TROLLEY BAGS.” GEM sells reusable shopping cart bags that use the mark “LOTUS TROLLEY BAGS.”

In July 2017, TB UK sent a cease-and-desist letter to GEM, asserting that GEM’s sale of Lotus Bags infringed the '828 patent and what it asserts is a “TROLLEY BAGS” common law trademark.<sup>1</sup> In September 2018, GEM then brought a declaratory judgment action against TB UK in the district court. GEM requested that the court find that (1) GEM did not infringe the '828 patent, (2) that the '828 patent was invalid for (a) obviousness over Doyle<sup>2</sup> and Brennan,<sup>3</sup> and (b) functionality, and (3) that GEM did not infringe TB UK’s common law trademark. Both parties then moved for summary judgment.

The district court granted GEM’s motion for summary judgment and held the '828 patent invalid for functionality and obviousness, alternatively found that GEM did not infringe the '828 patent, and found that GEM did not infringe TB UK’s common law trademark.

TB UK appealed the district court’s grant of summary judgment. We have jurisdiction pursuant to 28 U.S.C. §1295(a)(1).

---

<sup>1</sup> As common law trademarks are created by use, *see In re Int’l Flavors & Fragrances Inc.*, 183 F.3d 1361, 1366 (Fed. Cir. 1999), this suit against products containing such a mark effectively concedes the mark’s existence.

<sup>2</sup> Doyle, Irish Patent Pub. S2009/0718. Doyle is directed to a reusable bag system and is owned by TB UK.

<sup>3</sup> Brennan et al., U.S. Patent 5,046,860. Brennan is directed to reusable shopping bag assemblies.

## DISCUSSION

We review the grant of summary judgment under the law of the regional circuit from which the case originates. *See e.g., Grober v. Mako Prods., Inc.*, 686 F.3d 1335, 1344 (Fed. Cir. 2012). The Ninth Circuit reviews a district court's grant of summary judgment de novo. *See e.g., Branch Banking & Tr. Co. v. D.M.S.I., LLC*, 871 F.3d 751, 759 (9th Cir. 2017). Summary judgment is appropriate if, viewing the evidence in the light most favorable to the non-moving party, the movant shows that there is no genuine dispute as to any material fact and the movant is entitled to judgment as a matter of law. *See Whitman v. Mineta*, 541 F.3d 929, 931 (9th Cir. 2008); *see also Celotex Corp. v. Catrett*, 477 U.S. 317, 322 (1986).

## I. Functionality

The district court held that the '828 patent was invalid because its design was dictated by function. TB UK argues that the district court errs in that conclusion by asserting that it misapplied the *Sport Dimension* five-factor test relating to functionality. TB UK alleges that in the process of misapplying the test, the court failed to resolve disputed facts in favor of TB UK, the non-moving party, and applied the wrong legal standard, finding the patented design "dictated by function" instead of it being "dictated *solely* by function." Appellant's Br. at 13. GEM responds that the court properly applied the *Sport Dimension* test and correctly found the design of the '828 patent to be dictated by function.

A district court's finding that a patented design is dictated by function is reviewed for clear error. *See Ethicon Endo-Surgery, Inc. v. Covidien, Inc.*, 796 F.3d 1312, 1328 (Fed. Cir. 2015). For a design to be protectable by a design patent, "the design must not be governed solely by function, i.e., that this is not the only possible form of the article that could perform its function." *Rosco, Inc. v. Mirror Lite Co.*, 304 F.3d 1373, 1378 (Fed. Cir. 2002). A design patent is

GOLDEN EYE MEDIA USA, INC. v.  
EVO LIFESTYLE PRODUCTS LIMITED

5

invalid if the design is “dictated by the utilitarian purpose of the article.” *High Point Design LLC v. Buyer’s Direct, Inc.*, 730 F.3d 1301, 1315 (Fed. Cir. 2013) (internal quotation marks omitted). In determining whether a design is dictated by function, courts consider whether (1) “the protected design represents the best design,” (2) “alternative designs would adversely affect the utility of the specified article,” (3) “there are any concomitant utility patents,” (4) “the advertising touts particular features of the design as having specific utility,” and (5) “there are any elements in the design or an overall appearance clearly not dictated by function.” *Sport Dimension, Inc. v. Coleman Co.*, 820 F.3d 1316, 1322 (Fed. Cir. 2016).

We agree with GEM that the district court did not commit clear error when it found the design of the ’828 patent to be functional. The “availability of alternative designs [is] an important—if not dispositive—factor in evaluating the legal functionality of a claimed design.” *Ethicon*, 796 F.3d at 1329–30. After a thorough analysis, the court found that the horizontal poles of the claimed design were necessary for the purpose of the bag to fit in a cart while standing upright. *See Decision* at 1188. The court then found that an alternative design, for the poles or other features, would directly and adversely impact the functionality of the bag system and therefore that the first, second, and fifth *Sport Dimension* factors weighed in favor of invalidity. As for the third factor, whether there are any concomitant utility patents that shed light on the functionality of the U.S. design patent, the court found that Doyle, while owned by TB UK, was not classified as a utility patent in Ireland and that Brennan was not owned by TB UK. Based on these findings, the court found that this factor did not weigh in favor or against invalidity.

The court noted that, regarding the fourth factor, TB UK’s advertisements touted the utility of the bags. The court cited numerous examples demonstrating this fact, including a statement from TB UK’s website boasting that

the bags “halve the time at the checkout as packing is quicker and easier without the hassle of holding bags open.” *Decision* at 1192. The court therefore found that this factor weighed in favor of invalidity. We consider that these findings are not clearly erroneous, and thus we affirm its holding that the design of the ’828 patent is dictated by function. We also find that there are no genuine issues of material fact precluding summary judgment.

TB UK argues that the district court did not consider all the alternative designs presented, but that was not necessary. TB UK discussed two alternative designs: (1) using two, larger bags to fill a shopping cart, and (2) a bag system in which the designer chooses not to fill the entire capacity of a shopping cart with the bags. The court properly disposed of those alternatives when it mentioned that “the only evidence of alternative designs [TB UK has] presented is that their bags could be smaller or bigger such that they would or would not fill the entire cart” and that these alternatives “directly impact[] the utility of the [’]828 [p]atent.” *Decision* at 1186.

## II. Obviousness

TB UK also appeals the district court’s invalidation of the patent on the ground of obviousness. Having affirmed the patent’s invalidity for functionality we need not go further and review the obviousness determination. But, in the interest of thoroughness and because we are not the court of last resort, *see Cardinal Chemical Co. v. Morton Int’l, Inc.*, 508 U.S. 83 (1993), we will address that ground as well.

TB UK argues that the district court should have found that factual issues preclude a finding of summary judgment. In addition, it argues that the court erred in deciding that Doyle was a primary reference and that secondary references could be combined with Doyle to invalidate the ’828 patent. TB UK notes that the United States Patent and Trademark Office (“USPTO”) determined in its

GOLDEN EYE MEDIA USA, INC. v.  
EVO LIFESTYLE PRODUCTS LIMITED

7

reexamination that Doyle was not invalidating prior art and that it was too different from the design of the '828 patent to be considered a primary reference. TB UK asserts that the USPTO's determination underscores the incorrectness of the court's conclusion that no genuine issues of material fact existed.

GEM responds that the district court correctly determined that Doyle was a primary reference that exhibited design characteristics that were basically the same as in the '828 patent. GEM adds that the court properly found that Brennan was a secondary reference that could have been combined with Doyle to create a design with the same overall visual appearance as the claimed design of the '828 patent.

Obviousness is a question of law that is reviewed de novo, based on underlying factual questions that are reviewed for clear error. *Honeywell Int'l, Inc. v. United States*, 609 F.3d 1292, 1297 (Fed. Cir. 2010). The underlying factual inquiries include: (1) the scope and content of the prior art; (2) the level of ordinary skill in the art; (3) the differences between the claimed invention and the prior art; and (4) objective evidence of non-obviousness. *Graham v. John Deere Co. of Kan. City*, 383 U.S. 1, 17 (1966). Summary judgment of obviousness is appropriate if "the content of the prior art, the scope of the patent claim, and the level of ordinary skill in the art are not in material dispute, and the obviousness of the claim is apparent in light of these factors." *TriMed, Inc. v. Stryker Corp.*, 608 F.3d 1333, 1341 (Fed. Cir. 2010) (citing *KSR Int'l Co. v. Teleflex Inc.*, 550 U.S. 398, 427 (2007)).

A determination of obviousness in design patents requires a two-step inquiry designed to determine whether a designer of ordinary skill in the art would have combined prior art references to create a design with the same overall visual appearance as the claimed design. See *Durling v. Spectrum Furniture Co.*, 101 F.3d 100, 103 (Fed. Cir. 1996).

The first step is to identify “a single reference, ‘. . . something in existence, the design characteristics of which are basically the same as the claimed design.’” *Id.* (quoting *In re Rosen*, 673 F.2d 388, 391 (C.C.P.A. 1982)). To determine if a design is “basically the same,” the court looks to the “visual impression created by the patented design as a whole.” *Id.* This court has noted that “the trial court judge may determine almost instinctively whether the two designs create basically the same visual impression,” but “must communicate the reasoning behind th[at] decision.” *Id.*

In the second step, other references “may be used to modify [the primary reference] to create a design that has the same overall visual appearance as the claimed design.” *Id.* These secondary references must be “so related [to the primary reference] that the appearance of certain ornamental features in one would suggest the application of those features to the other.” *Id.*

We agree with GEM that the design of the ’828 patent was properly determined to have been obvious at the time it was created. In step one, the district court properly considered Doyle to be a primary reference. Despite Doyle having a different handle design and location, horizontal rods that differ in length and design, and a less rectangular shape compared to the ’828 patent’s design, the court concluded that the two designs created “basically the same” visual impression:

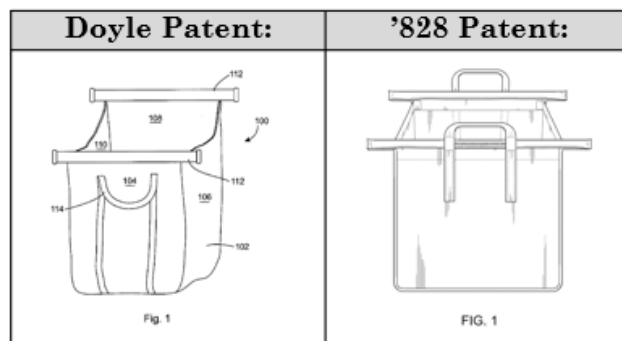



GOLDEN EYE MEDIA USA, INC. v.  
EVO LIFESTYLE PRODUCTS LIMITED

9

*Decision* at 1198.

The district court’s conclusion is consistent with our precedent where we have found that primary references may contain slight differences relative to a patented design. *See Spigen Korea Co. v. Ultraproof, Inc.*, 955 F.3d 1379, 1383 (Fed. Cir. 2020) (explaining that “slight differences” do not preclude a “basically the same” finding). Regarding the difference in the handles, the court noted that “the Doyle Patent merely illustrates the flexibility of the handles while the [’828] patent shows the handles in an upright position.” *Decision* at 1206. The court next concluded that any perceived difference in the length of the bag’s horizontal rod is slight and does not preclude a finding that the bags are “basically the same.” Lastly, the court also found the difference in the shape of the bags to be only slight. These findings regarding the differences between Doyle and the ’828 patent are not clearly erroneous, and thus we find that the court properly considered Doyle to be a primary reference.

In step two, the district court properly analyzed multiple secondary references and concluded that the combination of Doyle as a primary reference and Brennan as a secondary reference rendered the ’828 patent obvious. Brennan contains similar handle stitching to the ’828 patent, and these handles combined with the bag shape and handles of Doyle would create a shopping cart bag that highly resembles the one claimed by the ’828 patent:

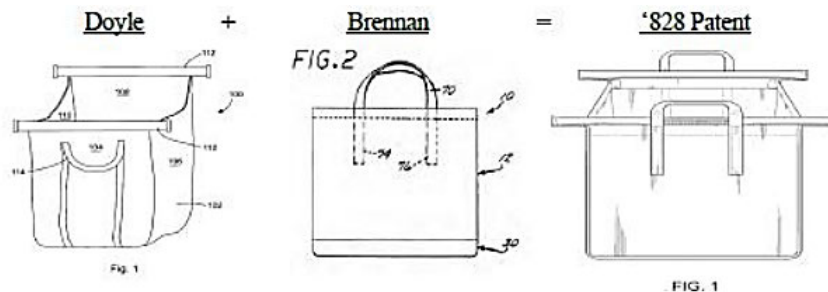

*Decision* at 1204.

The district court therefore did not commit clear error by combining Doyle and Brennan and determining that the combination of these two references would have rendered the '828 patent obvious. Thus, we affirm the court's holding that the combination of Doyle and Brennan invalidated the '828 patented design for being obvious.

In light of our affirmance of the district court's separate holdings of invalidity on both functionality and obviousness, the court's decision addressing infringement is moot. We thus do not address TB UK's appeal from that portion of the court's decision.

### III. Trademark Infringement

TB UK argues that the district court improperly weighed and critiqued underlying evidence when conducting its likelihood of confusion analysis relating to the trademark claim. GEM responds that TB UK failed to present any evidence showing a likelihood of confusion, and the court properly found that there was no genuine dispute of material fact concerning likelihood of confusion.

We have jurisdiction over the appeal of the district court's summary judgment ruling against TB UK's trademark infringement claim because it was part of a complaint containing non-frivolous claims of patent infringement. *See Atari, Inc. v. JS & A Grp., Inc.*, 747 F.2d 1422, 1427–30 (Fed. Cir. 1984) (discussing appellate jurisdiction over copyright and other non-patent issues in the Federal Circuit when a complaint also includes a claim arising under patent law); *see also Zenith Elecs. Corp. v. Exzec, Inc.*, 182 F.3d 1340, 1346 (Fed. Cir. 1999) (“Because the complaint contained patent infringement claims, the district court’s jurisdiction arose under 28 U.S.C. § 1338(a). This established the path of appeal, giving exclusive jurisdiction in this court pursuant to . . . ¶ 1295(a)(1).”); *Abbott Lab’s v. Brennan*, 952 F.2d 1346, 1349–50 (Fed. Cir. 1991) (“The path of appeal is determined by the basis of jurisdiction in the district court, and is not controlled by the

GOLDEN EYE MEDIA USA, INC. v.  
EVO LIFESTYLE PRODUCTS LIMITED

11

district court’s decision or the substance of the issues that are appealed.”).

“In a trademark case, we apply the law of the applicable regional circuit, in this case, the Ninth Circuit.” *Nautilus Grp., Inc. v. ICON Health & Fitness, Inc.*, 372 F.3d 1330, 1334 (Fed. Cir. 2004). “Likelihood of confusion is the type of mixed question [that is] suited to clearly erroneous review.” *Levi Strauss & Co. v. Blue Bell, Inc.*, 778 F.2d 1352, 1355 (9th Cir. 1985) (en banc). The Ninth Circuit examines eight factors when evaluating trademark infringement claims. *AMF Inc. v. Sleekcraft Boats*, 599 F.2d 341, 348–49 (9th Cir. 1979). These eight factors are: (1) strength of the mark, (2) proximity of the goods in trade channels, (3) similarity of the marks, (4) evidence of actual confusion, (5) marketing channels used, (6) type of goods and the degree of care likely to be exercised by the purchaser, (7) defendant’s intent in selecting the mark, and (8) likelihood of expansion of the product lines. *Id.*

We agree with GEM that the district court properly analyzed the *Sleekcraft* factors and held that there was no genuine dispute of material fact as to noninfringement of TB UK’s “TROLLEY BAGS” trademark. In analyzing the “trolley bag” logo of GEM’s product and TB UK’s product, the court first noted that the two logos were markedly different:



*See Decision* at 1220. A quick inspection, see above, shows the words TROLLEY BAG to be of quite different size and location in the overall mark, and the colors are also very different. Despite these differences, the court construed TB UK's trademark infringement claims to pertain to the use of "TROLLEY BAG" in each logo. Under this construction, the court analyzed each of the *Sleekcraft* factors and found that, while the proximity of the goods factor weighed in TB UK's favor, all other factors weighed in GEM's favor. The court also noted that, despite both marks using the "TROLLEY BAG" term, the dominance of other logos on the bags, distinctive coloring, and overall appearance made the marks dissimilar. Lastly, the court pointed out that TB UK failed to provide evidence of actual confusion from use of the marks. For these reasons, the court found that there was no genuine dispute of material fact as to the likelihood of confusion and that TB UK's common law trademark was not infringed. The court's analysis of the *Sleekcraft* factors was not clearly erroneous, and we do not find any instance where the court overstepped its role by improperly weighing and critiquing underlying evidence. Thus, we affirm the court's holding that the "TROLLEY BAGS" common law trademark was not infringed.

#### CONCLUSION

We have considered TB UK's remaining arguments but find them unpersuasive. For the foregoing reasons, the decision of the district court is *affirmed*.

**AFFIRMED**